

PLAN DE MONTAGE COUVERCLE RAINBOW CV-R

PLANO DE MONTAJE CUBIERTA RAINBOW CV-R
ASSEMBLY INSTRUCTIONS RAINBOW LID CV-R
MONTAGEANLEITUNG DECKEL RAINBOW CV-R
ISTRUZIONE COPERCHIO RAINBOW CV- R

1

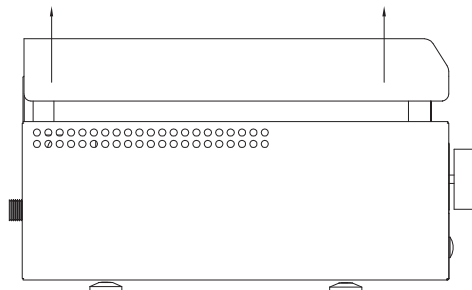
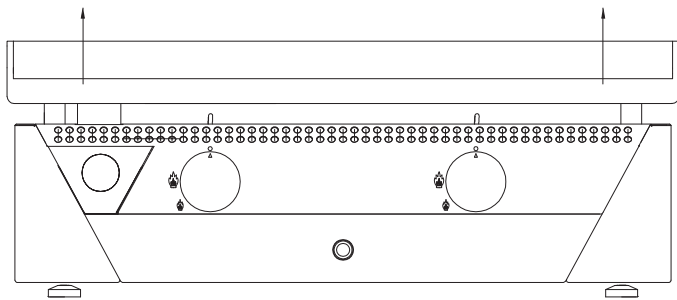

- FR Retirer la plaque.
ES Quitar la placa.
EN Remove plate.
DE Plancha-bräter abnehmen.
IT Rimuovere la piastra plancha.

2

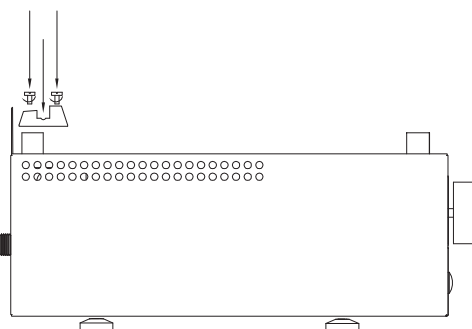
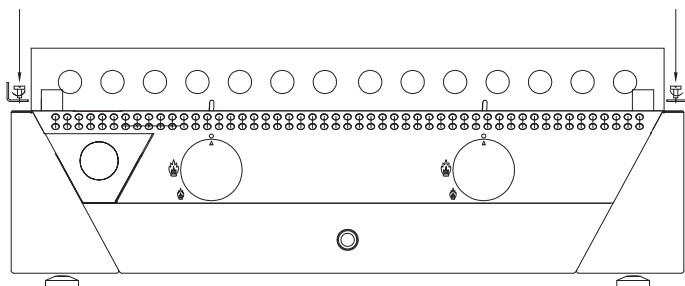

- FR Fixer les boulons.
ES Colocar los tornillos.
EN Fix screws.
DE Schrauben anziehen.
IT Fissare le vite.

3

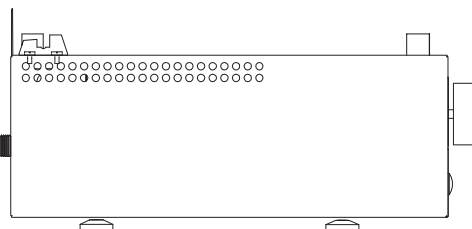
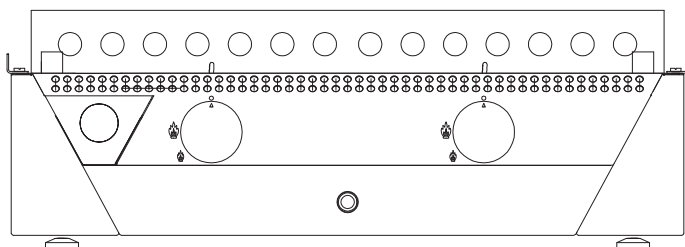

- FR Boulons fixés à la partie arrière.
ES Tornillos colocados en la parte trasera.
EN Fixed screws on the rear side.
DE Angezogene schrauben von hinten.
IT Fissate le vite da dietro.

4

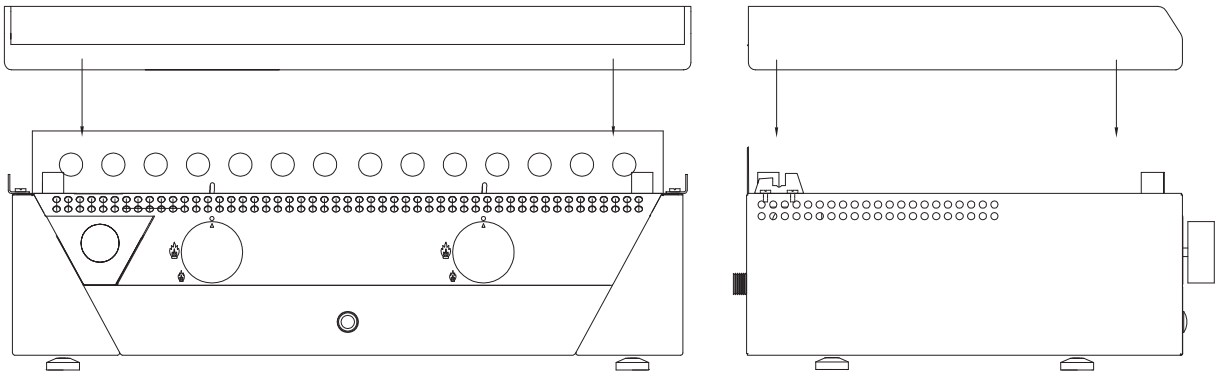

- FR Remettre la plaque.
- ES Encajar la cubierta.
- EN Replace the plate.
- DE Den plancha-bräter wieder aufsetzen.
- IT Rimettere la piastra plancha.

5

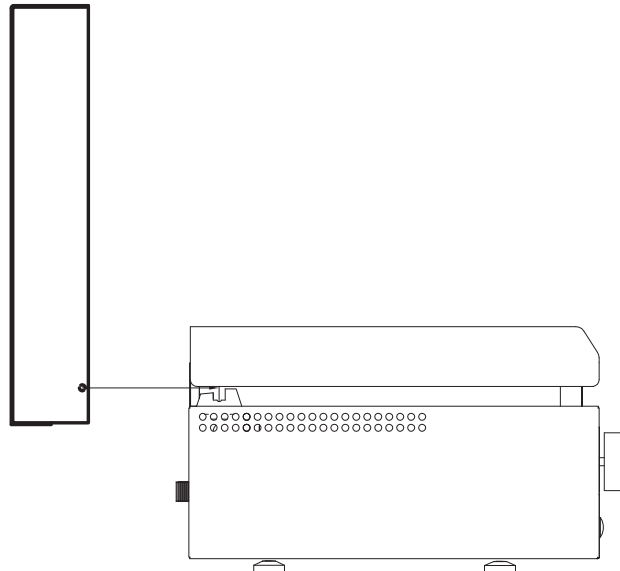

- FR Emboiter le couvercle.
- ES Encajar la cubierta.
- EN Insert lid.
- DE Deckel montieren.
- IT Montare il coperchio.

6

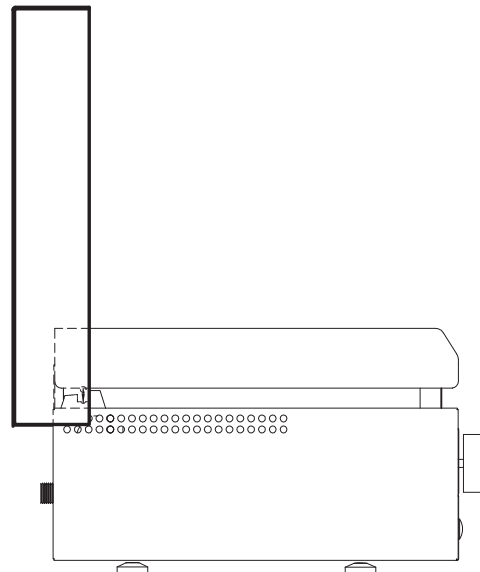

- FR Fermer le couvercle pour vérifier qu'il est correctement installé.
- ES Bajar la cubierta para comprobar que está instalada correctamente.
- EN Close lid to verify that it is correctly installed.
- DE Deckel schliessen um zu prüfen, dass er korrekt montiert ist.
- IT Chiudere il coperchio per verificare se é montato correttamente.